

## บทที่ 9

การเชื่อมต่อ และควบคุมอุปกรณ์ IoT ผ่าน  
อินเทอร์เน็ตด้วยแพลตฟอร์ม Blynk IoT

## จุดประสงค์การเรียนรู้

1. ศึกษาการเปิด/ปิดไฟบ้านผ่านอินเทอร์เน็ตบนแพลตฟอร์ม Blynk

# การทดลองที่ 1 การเปิด/ปิดไฟบ้านผ่านอินเทอร์เน็ตบนแพลตฟอร์ม Blynk

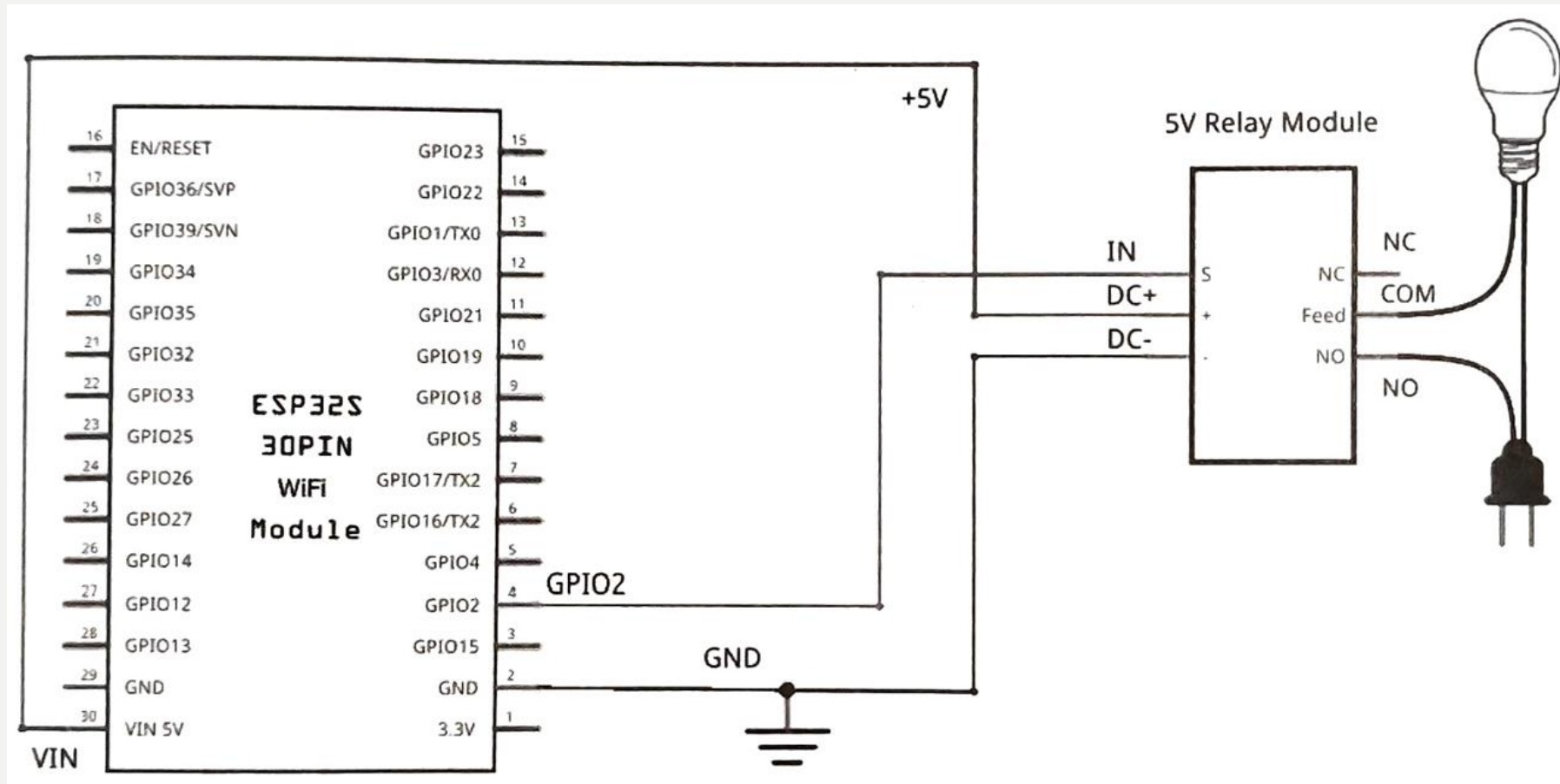

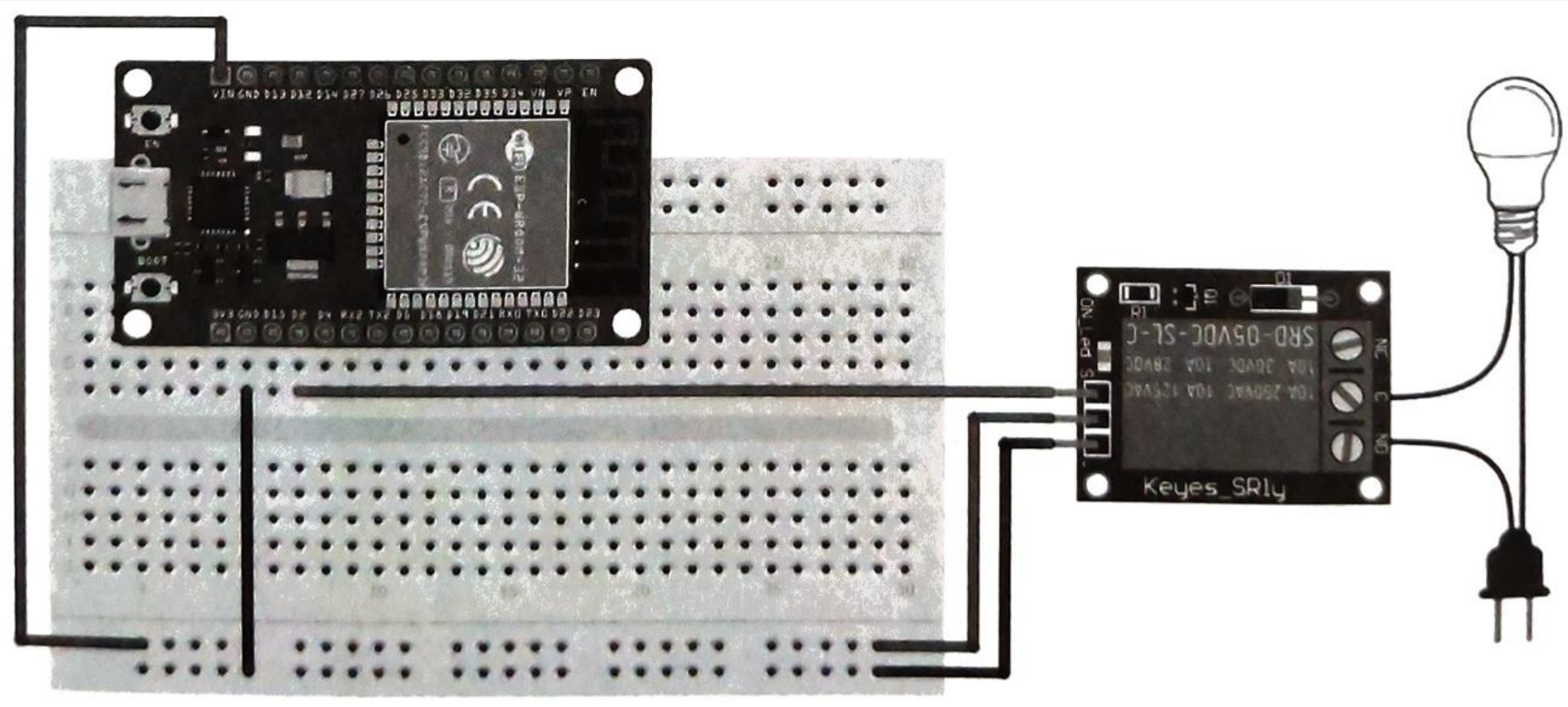

<https://blynk.cloud/dashboard/login>

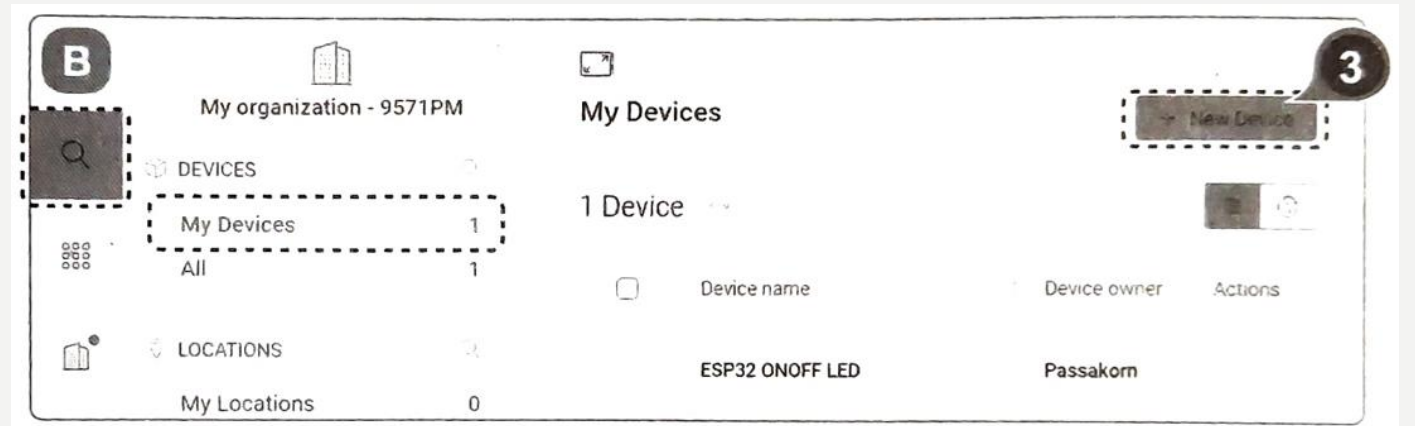
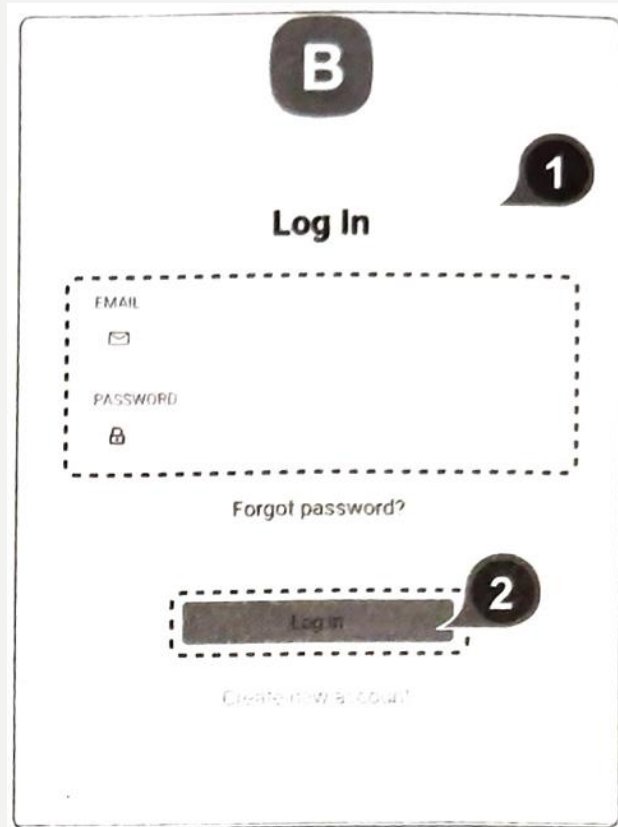

## New Device

Choose a way to create new device

From template



4

Scan QR code



Manual entry



+ Create a device by filling in a simple form

Cancel

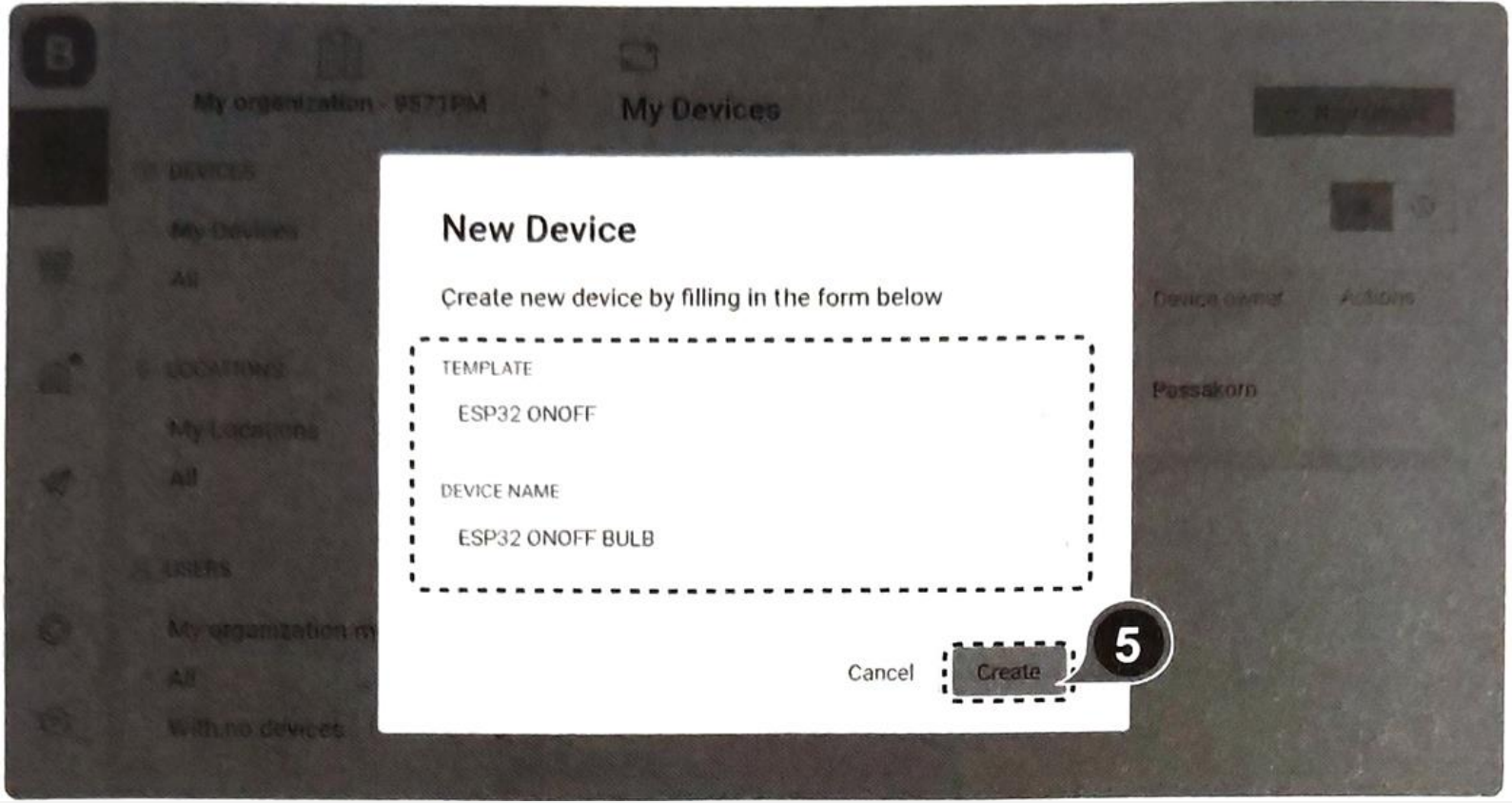



**B** My organization - 9571PM

← **Back**

Search

2 Devices

- ESP32 ONOFF LED
- ESP32 ONOFF BULB

Click to copy Code

```
#define BLYNK_TEMPLATE_ID "TMPL6CE_L_AN"  
#define BLYNK_DEVICE_NAME "ESP32 ONOFF BULB"  
#define BLYNK_AUTH_TOKEN  
"ZUh2xIGAaNFcUxJ7TbJAUBKfel1ljzBI"
```

6

Template ID, Device Name, and AuthToken should be declared at the very top of the firmware code.

Documentation Copy to clipboard

เปิด



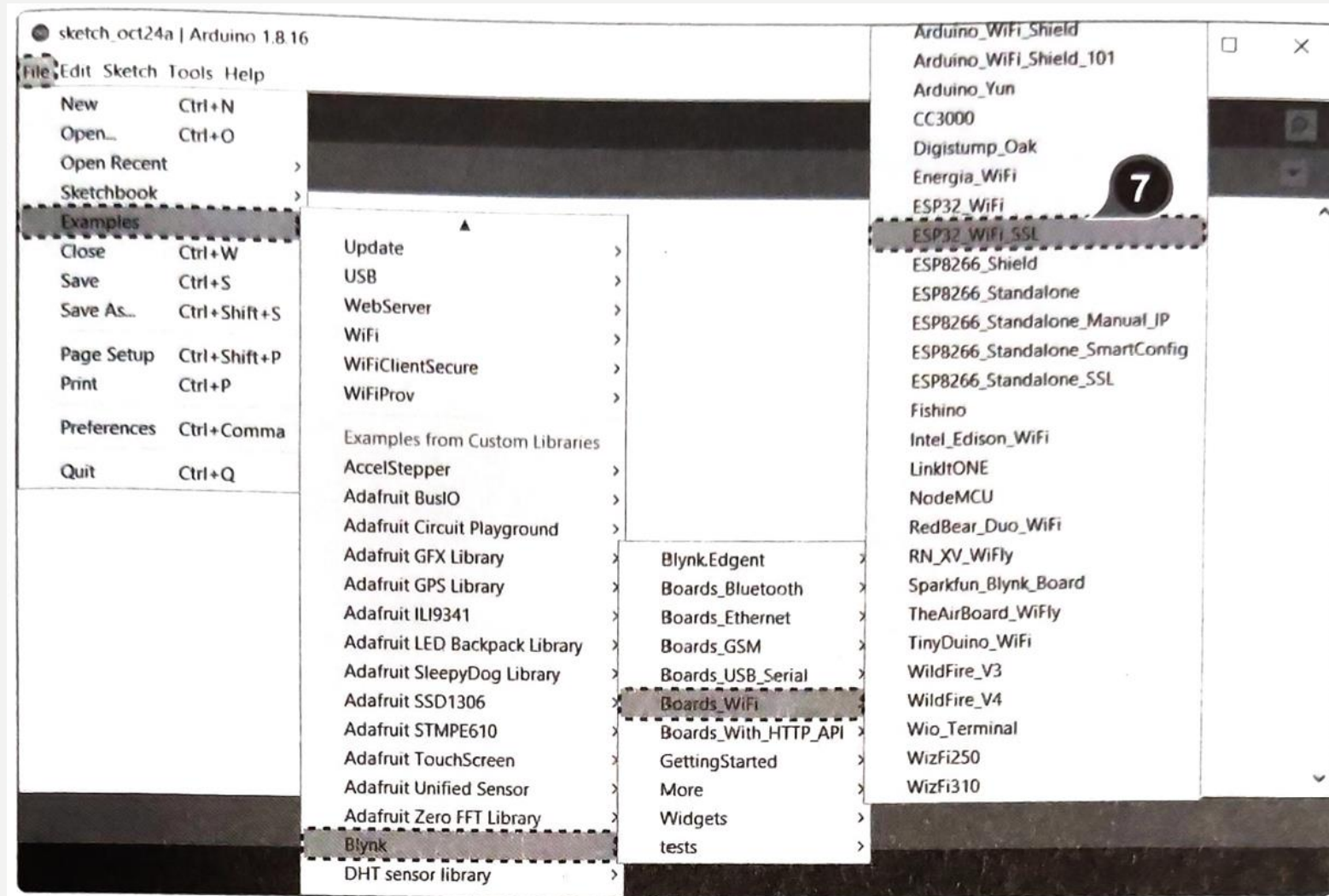



ESP32\_WiFi\_SSL \$

```
33 #define BLYNK_PRINT Serial
34
35 // Fill in your Template ID (only if using Blynk Cloud)
36 #define BLYNK_TEMPLATE_ID "TMPLaCE_L_AN"
37 #define BLYNK_DEVICE_NAME "ESP32 ONOFF BULB"
38 #define BLYNK_AUTH_TOKEN "ZUh2xIGAaNFcUxJ7RWJAUBKfelT1jzBI";
39 -----
40 #include <WiFi.h>
41 #include <WiFiClientSecure.h>
42 #include <BlynkSimpleEsp32_SSL.h>
43
44 // You should get Auth Token in the Blynk App.
45 // Go to the Project Settings (our APP) -----
46 char auth[] = "ZUh2xIGAaNFcUxJ7RWJAUBKfelT1jzBI";
47 -----
48 // Your WiFi credentials.
49 // Set password to "" for open networks.
50 char ssid[] = "YourNetworkName";
51 char pass[] = "YourPassword";
52 -----
53 void setup()
54 -----
55 // Debug console
56 Serial.begin(115200);
```

8

```
#define BLYNK_PRINT Serial //รายงานสถานะการเชื่อมต่อของ Blynk ออก Serial Monitor
```

```
#define BLYNK_TEMPLATE_ID "TMPLaCE_L_AN"
```

```
#define BLYNK_DEVICE_NAME "ESP32 ONOFF BULB"
```

```
#define BLYNK_AUTH_TOKEN "ZUh2xIGAunFcUxJ7RWJAUBKfe1T1jzBI";
```



9

```

#include <WiFi.h> //เรียกใช้ไลบรารี WiFi.h
#include <WiFiClientSecure.h> //เรียกใช้ไลบรารี WiFiClientSecure.h
#include <BlynkSimpleEsp32_SSL.h> //เรียกใช้ไลบรารี BlynkSimpleEsp32_SSL.h

char auth[] = "YourAuthToken"; //ก๊อปปรีแฮส Token ที่ได้รับมาใส่ลงใน " " เช่น char auth[]
= "ZUh2xIGAUNFcUxJ7RWJAUBKfelTljzBI";

char ssid[] = "YourNetworkName"; //ใส่ชื่อ SSID ของ WiFi Network ที่จะให้อุปกรณ์ IoT
เชื่อมต่อ ลงใน " "
char pass[] = "YourPassword"; //ใส่รหัสผ่านที่จะเชื่อมต่อกับ WiFi Network ลงใน " "

void setup()
{
  Serial.begin(115200);
  Blynk.begin(auth, ssid, pass); //เริ่มต้นกระบวนการเชื่อมต่อกับ WiFi Network
  และ Blynk Cloud
}

void loop()
{
  Blynk.run(); //ระบบ Blynk เริ่มการทำงาน
}

```

COM4

```
[21] Connecting to TRUE_2.4G_USSANEE
[4139] Connected to WiFi
[4139] IP: 192.168.1.41
[4139]
```

10

```
  _ _ ) / / _ _ _ _ _ / / _ _
 / _ / / / / / _ \ / ' /
 / _ _ / \ , / / / / \ \
      / _ / v1.0.1 on ESP32
```

```
[4149] Connecting to blynk.cloud:443
[6047] Certificate OK
[6081] Ready (ping: 33ms).
```



**B** **Templates** + New Template

Search Templates

**11**

ESP32 ONOFF  
2 Devices

**B** **ESP32 ONOFF** Clone **12** Edit

Info Metadata Datastreams Events Web Dashboard Mobile Dashboard

**Web Dashboard Template** X

Set how the dashboard of the devices will look like. Use search to find the device with real data

เปิดปิดไฟ LED (5)  ปิด

B

# ESP32 ONOFF

Delete

Cancel

Save



Info

Metadata

Datastreams

Events

Web Dashboard

Mobile Dashboard



Slider

— • + 8

---

Switch

---

Label

112

---

Gauge

เปิดปิดไฟ LED (5)

ปิด

---

Switch

 

**13**



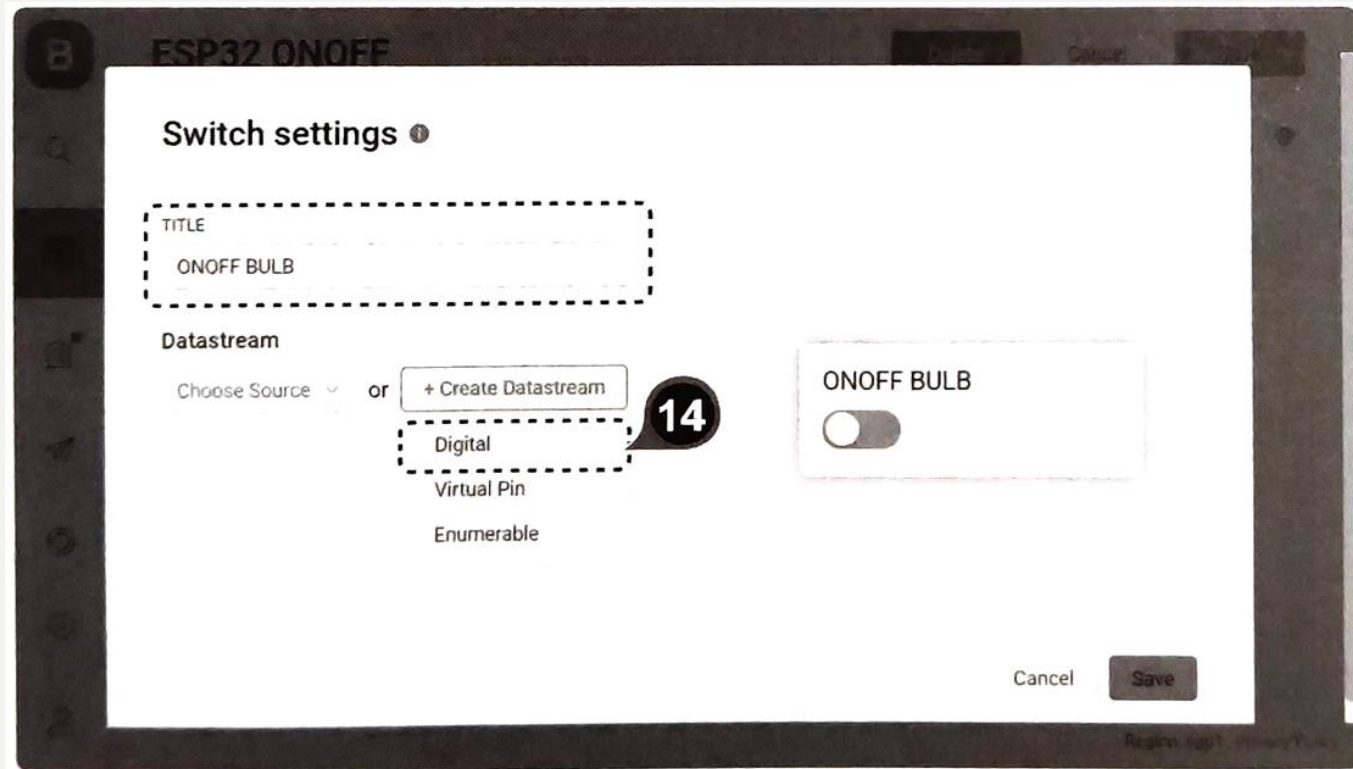

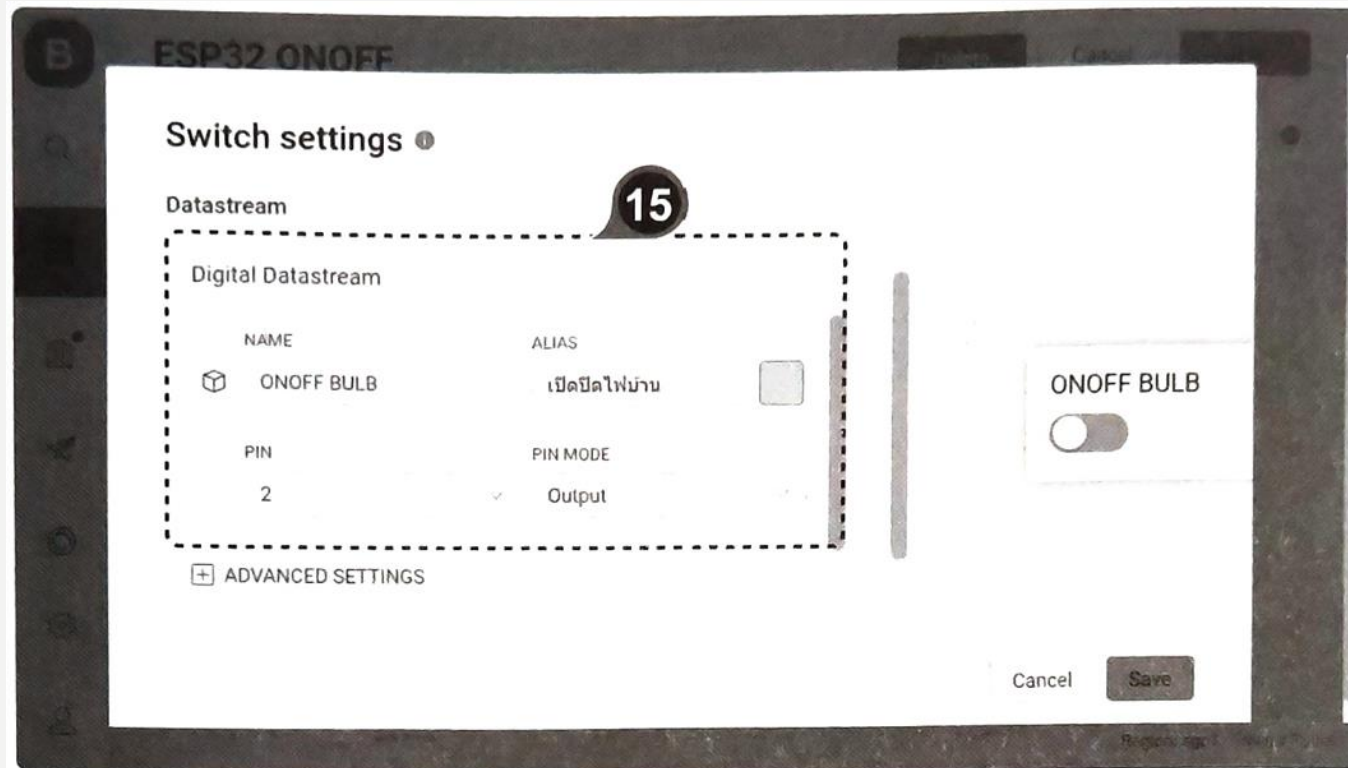

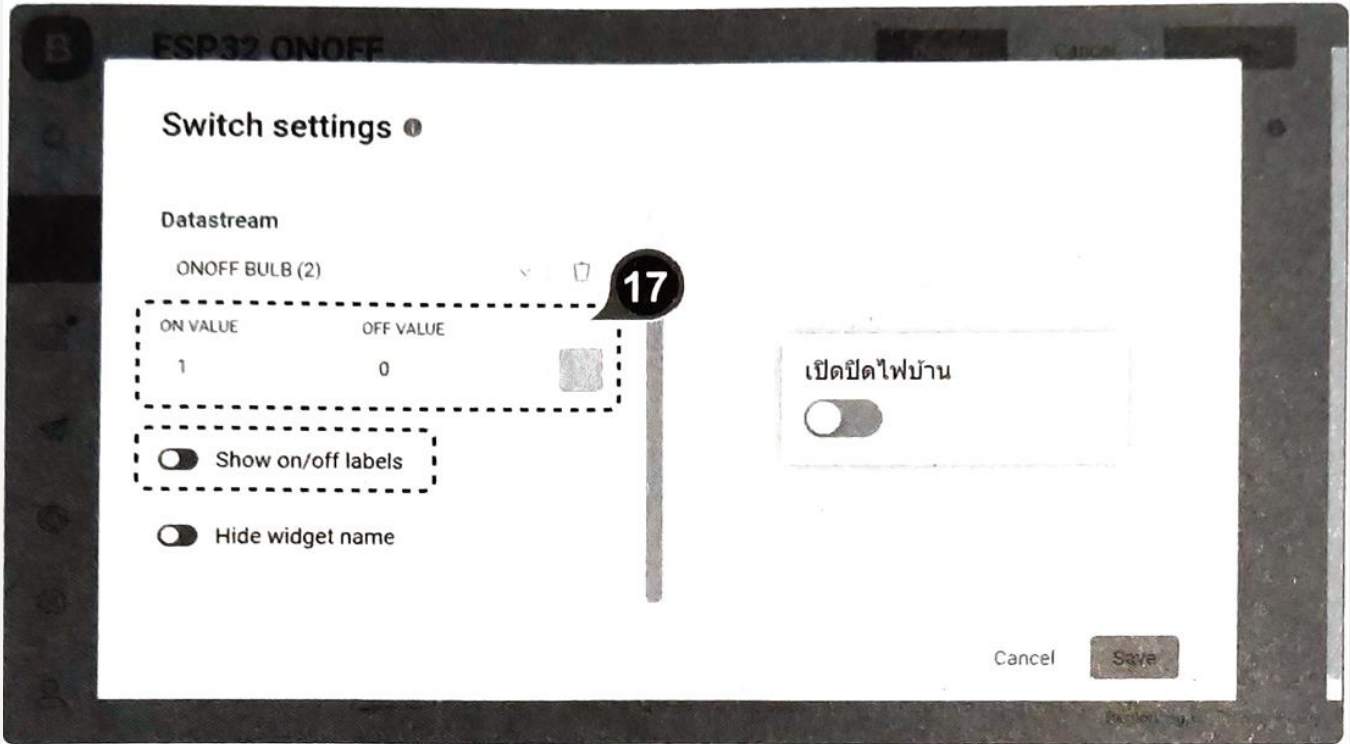

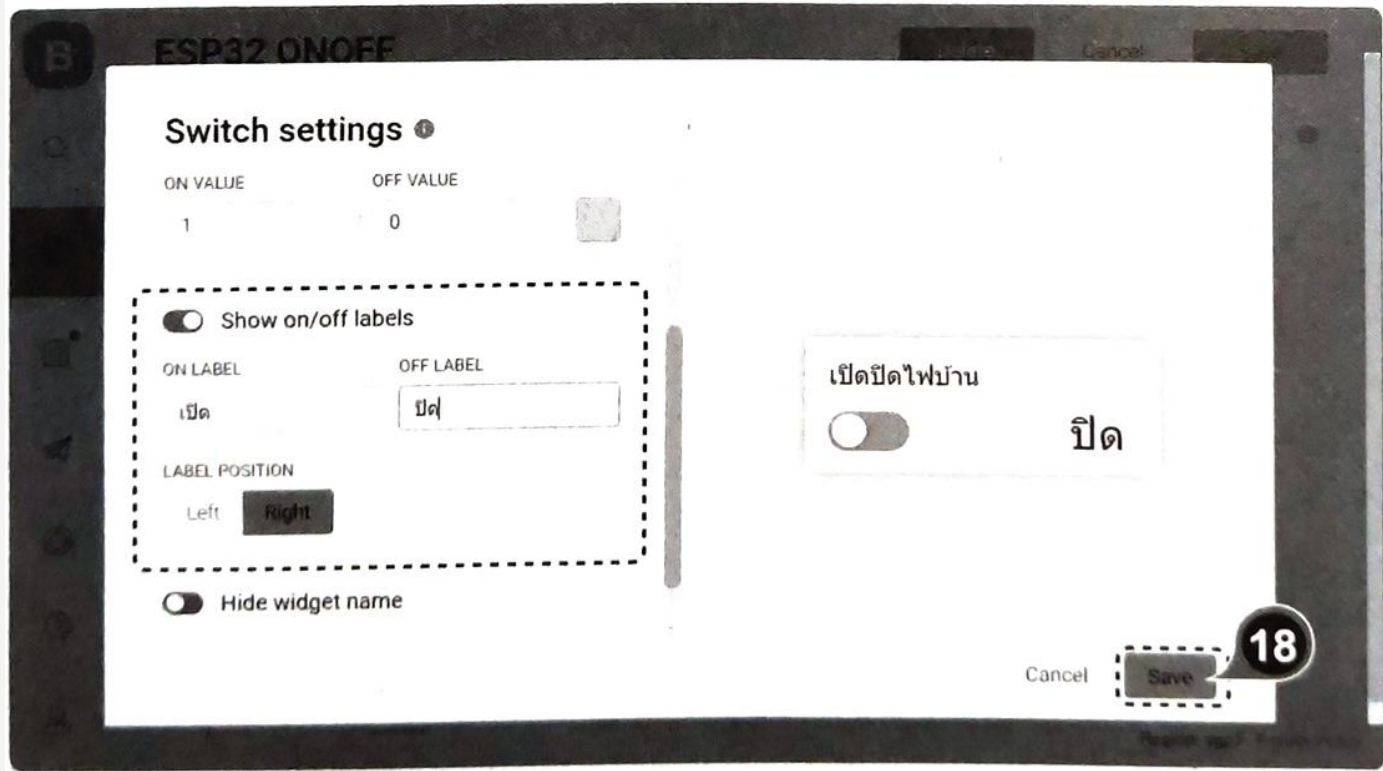

### Switch settings

ON VALUE: 1      OFF VALUE: 0

Show on/off labels

ON LABEL:       OFF LABEL:

LABEL POSITION:  Left       Right

Hide widget name

เปิดปิดไฟบ้าน

     ปิด

Cancel

Save

18

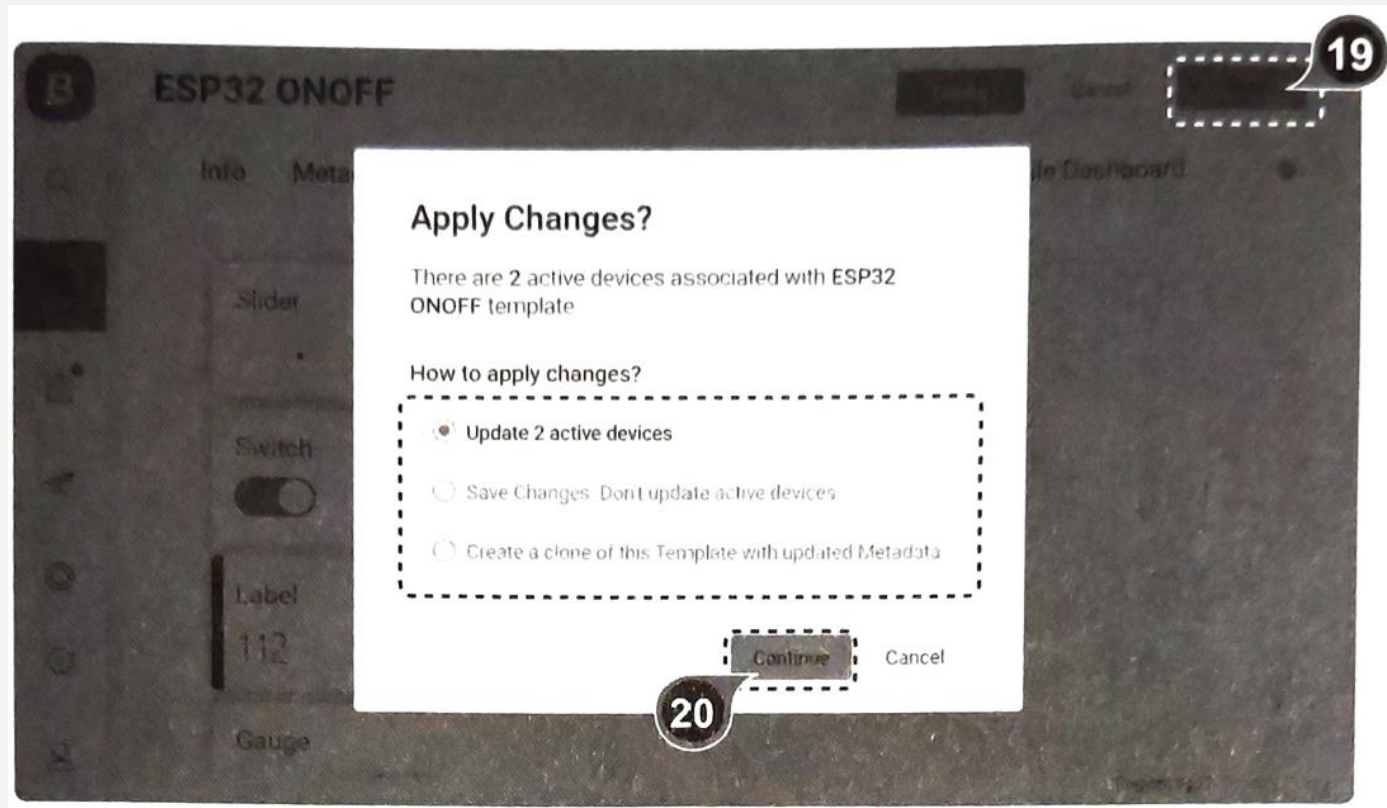

**B** My organization - 9571PM

**My Devices** New Device

DEVICES

- My Devices 2
- All 2

LOCATIONS

- My Locations 0
- All 0

USERS

- My organization members 1
- All 1
- With no devices 0

2 Devices

Device name	Device owner	Actions
ESP32 ONOFF BULB	Passakorn	21
ESP32 ONOFF LED	Passakorn	

**B** My organization - 9571PM

ESP32 ONOFF BULB Online

Passakorn My organization 9571PM

Add Tag

Dashboard Timeline Device Info Metadata

2 Devices

- ESP32 ONOFF BULB
- ESP32 ONOFF LED

เปิดปิดไฟ LED  ปิด

เปิดปิดไฟบ้าน  ปิด

Region: sgp1 Privacy Policy

22



✕ □

### ESP32 ONOFF BULB Offline

Passakorn My organization - 9571PM

Add Tag

Dashboard Timeline Device Info Metadata ...

เปิดปิดไฟ LED  ปิด

เปิดปิดไฟบ้าน  ปิด

Region: sgp1

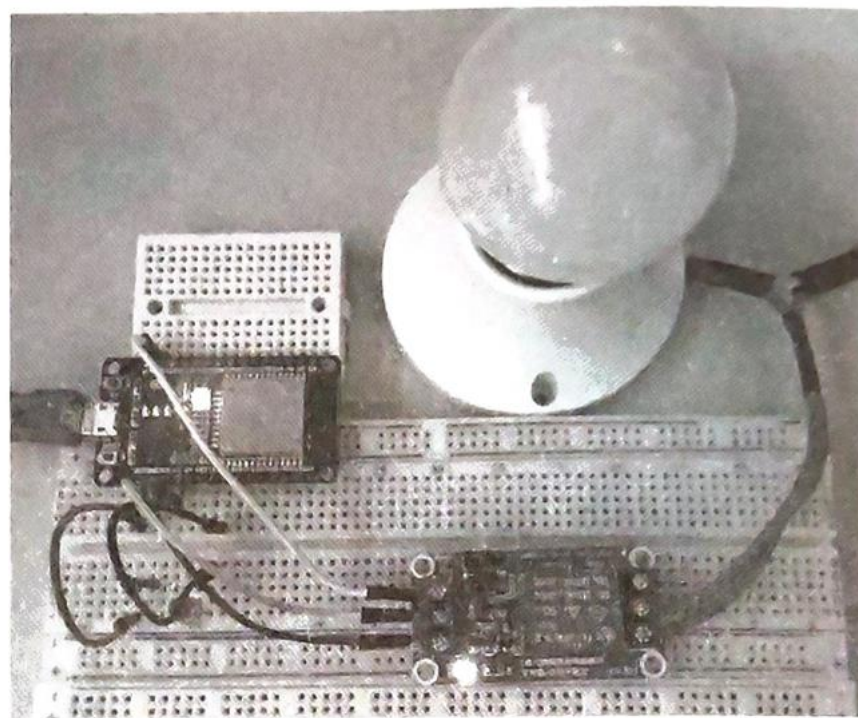

✕ 🖼️

### ESP32 ONOFF BULB Online

👤 Passakorn 🏢 My organization - 9571PM

🏷️ Add Tag

Dashboard Timeline Device Info Metadata

เปิดปิดไฟ LED

เปิด

---

เปิดปิดไฟบ้าน

ปิด

Region: sgp1 Privacy Policy

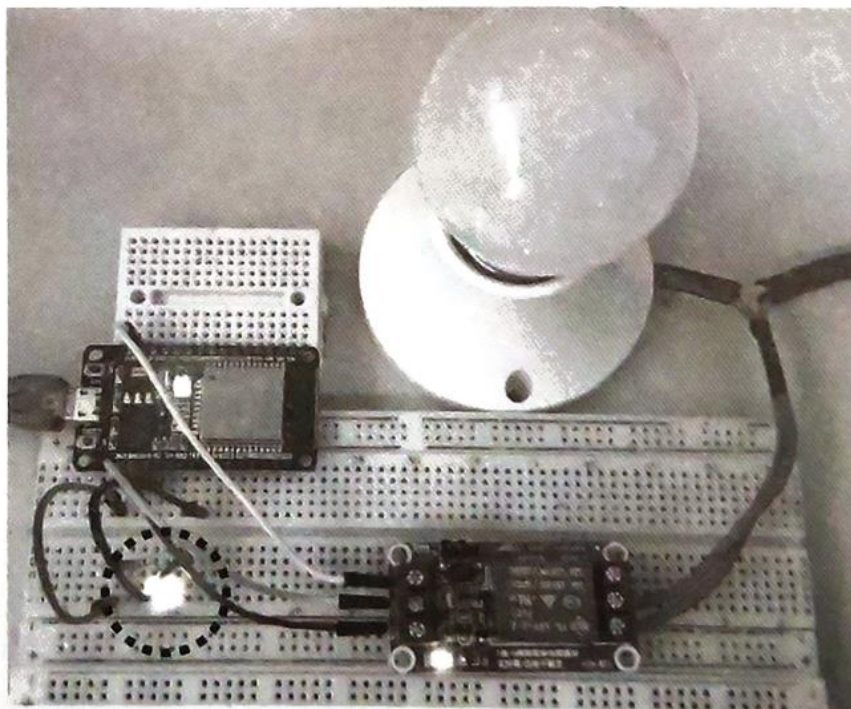

ESP32 ONOFF BULB Online

Passakorn My organization  
9571PM

Add Tag

Dashboard Timeline Device Info Metadata ...

เปิดปิดไฟ LED  เปิด

เปิดปิดไฟบาน  เปิด

Region: sgp1 Energy Po...

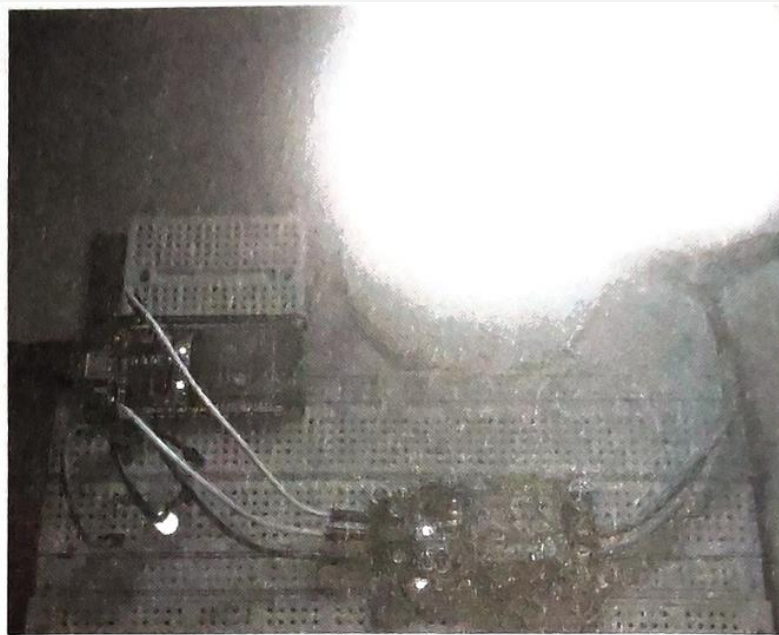

ESP32 ONOFF BULB Online

Passakorn My organization - 9571PM

Add Tag

Dashboard Timeline Device Info Metadata

เปิดปิดไฟ LED  ปิด

เปิดปิดไฟบ้าน  เปิด

Region: app1 Privacy Policy

